

A**S228-P/3/20****10 90 CC 40**

2 / 5

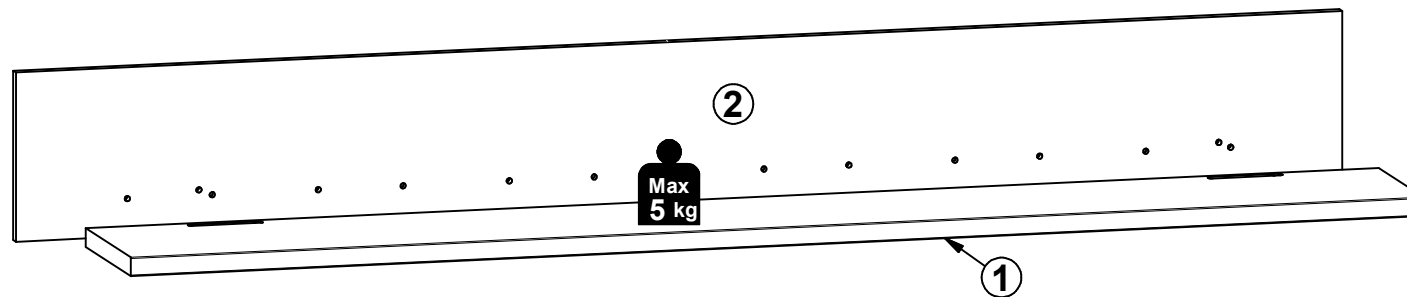

A	B	C (mm)		D
1	S228-321	1950	254	1/1
2	S228-406	2000	250	1/1

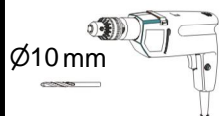
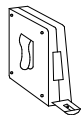
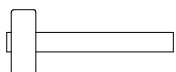
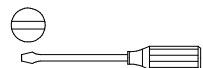
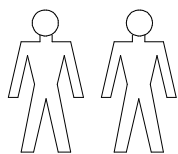
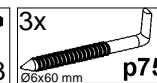
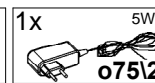
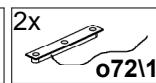
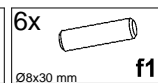
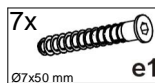
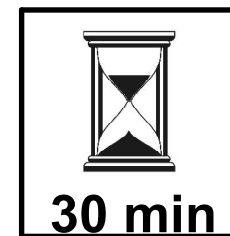

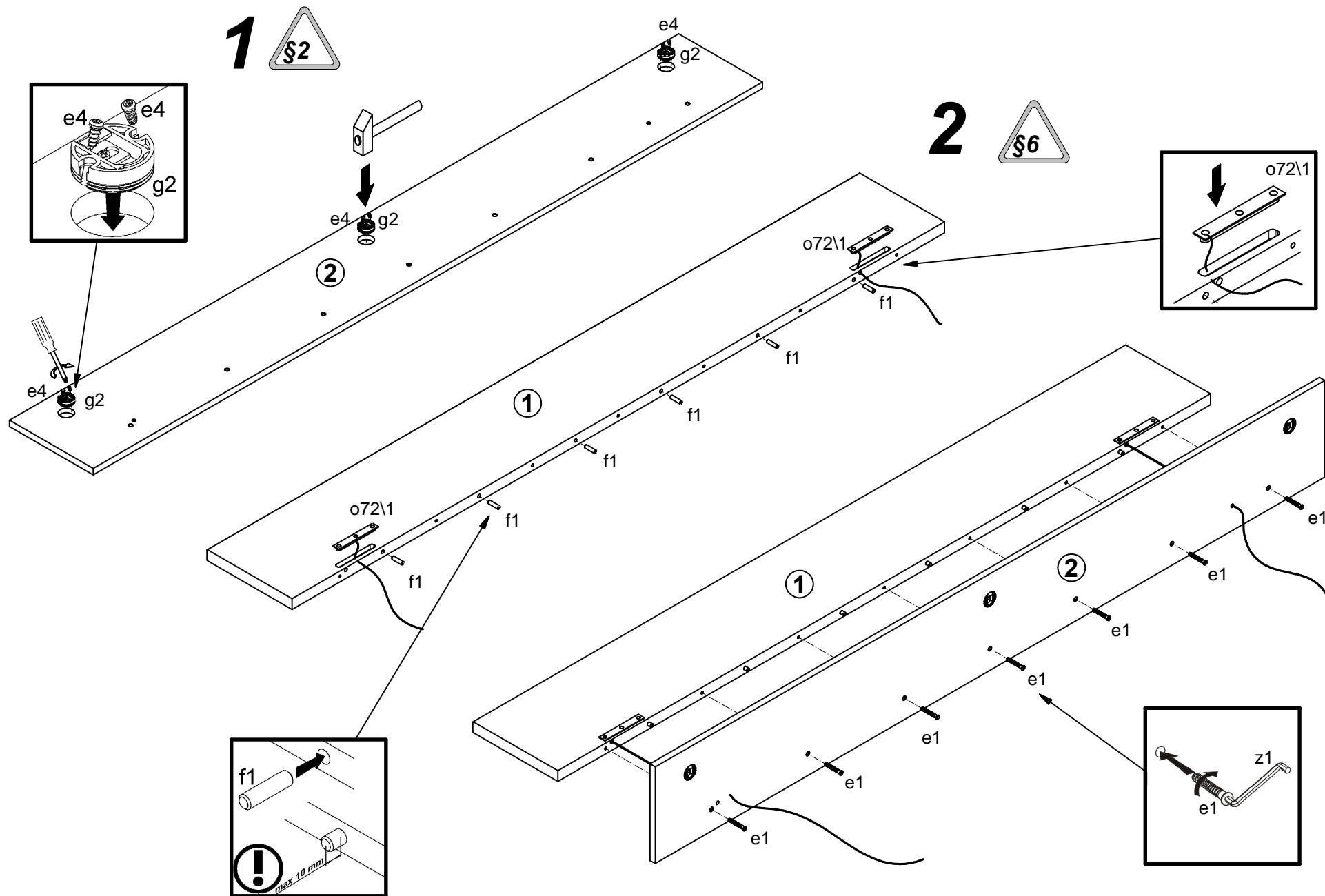

3

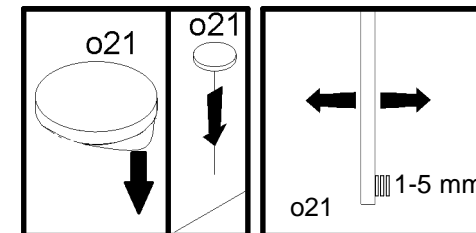
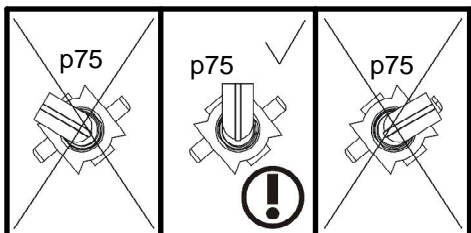
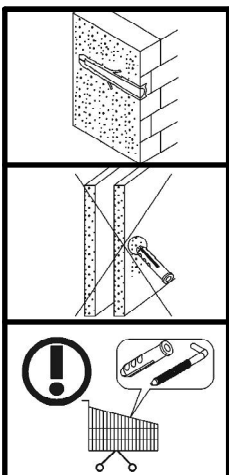
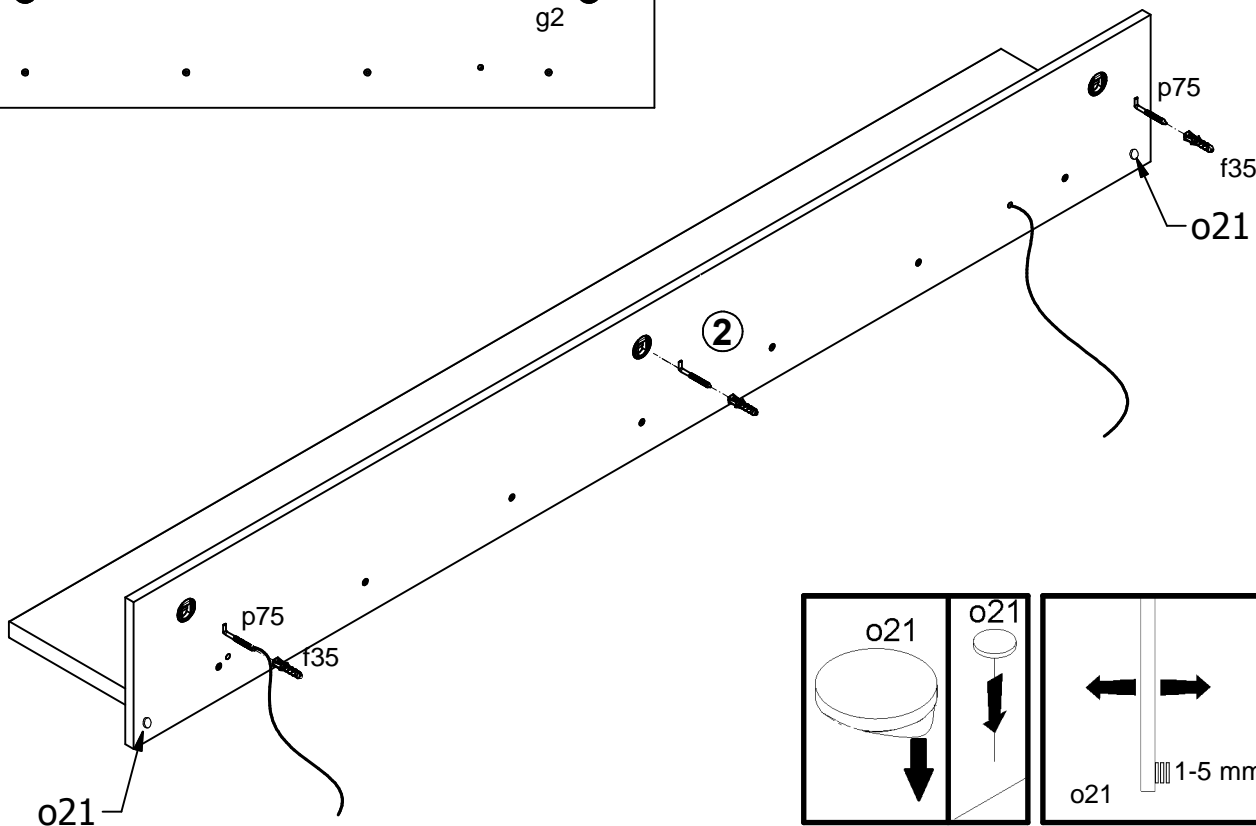
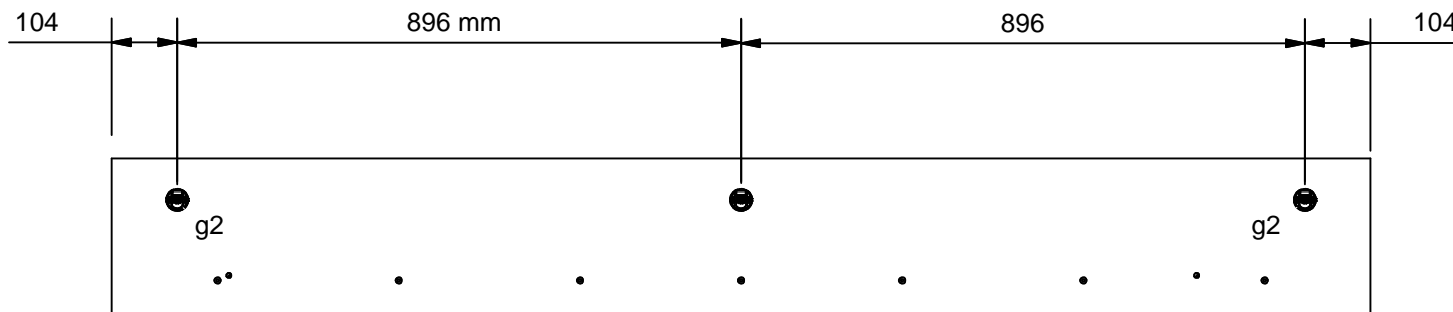
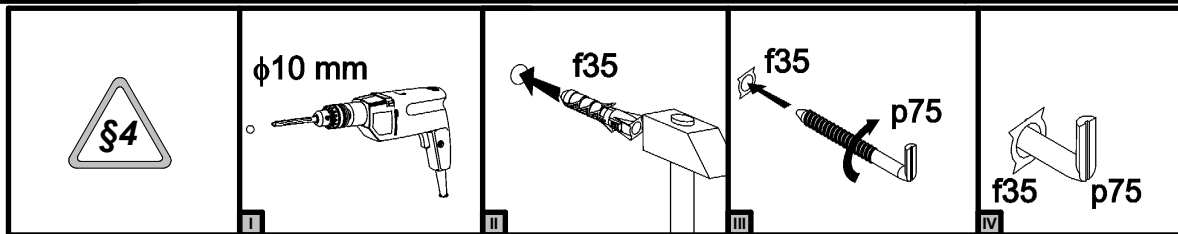

4

