

A**S228-P/3/14****10 90 CC 41**

2 / 5

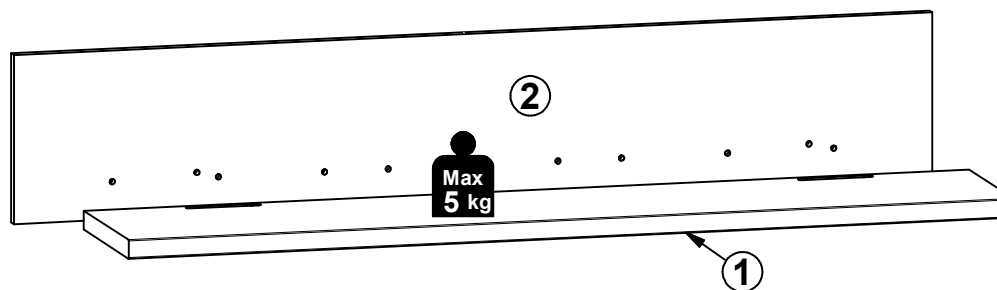

A	B	C (mm)		D
1	S228-322	1335	254	1/1
2	S228-407	1385	250	1/1

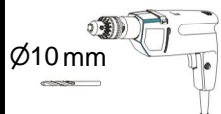
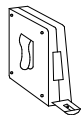
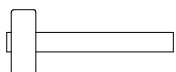
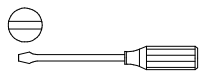
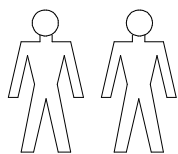
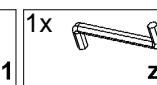
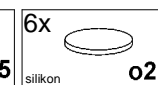
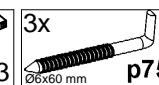
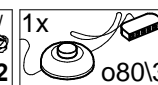
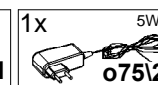
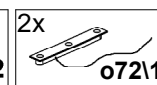
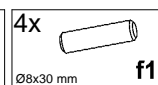
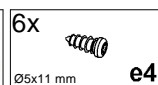
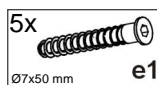

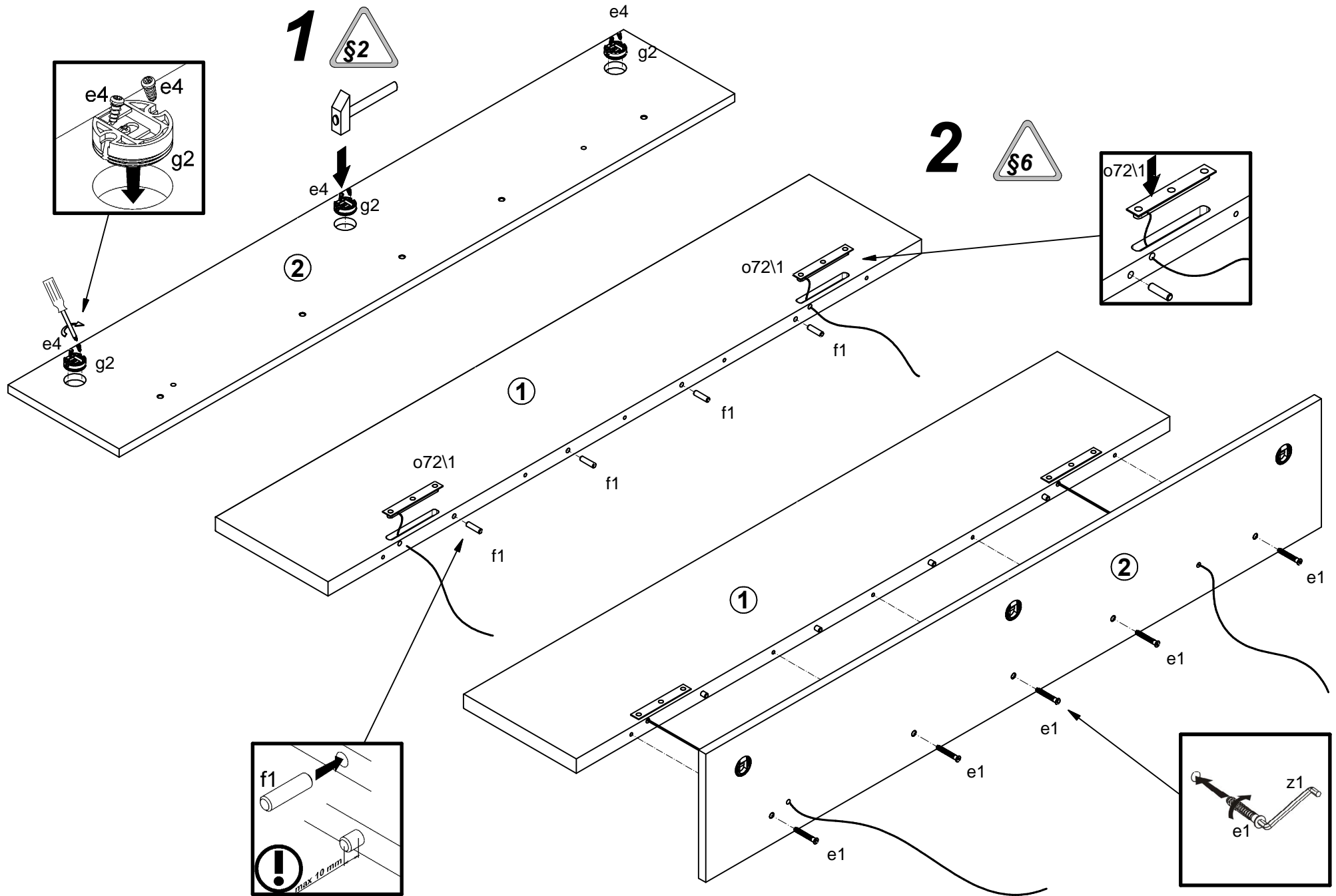

3

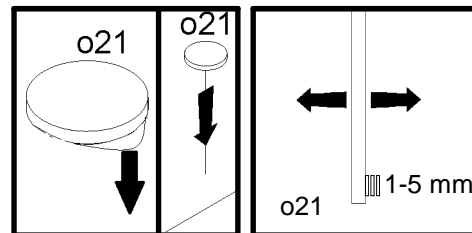
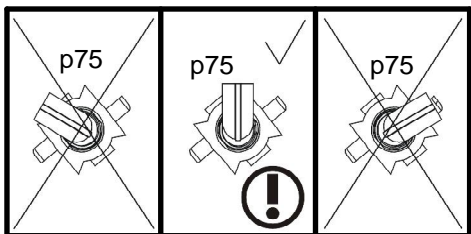
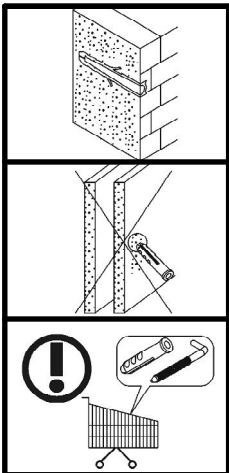
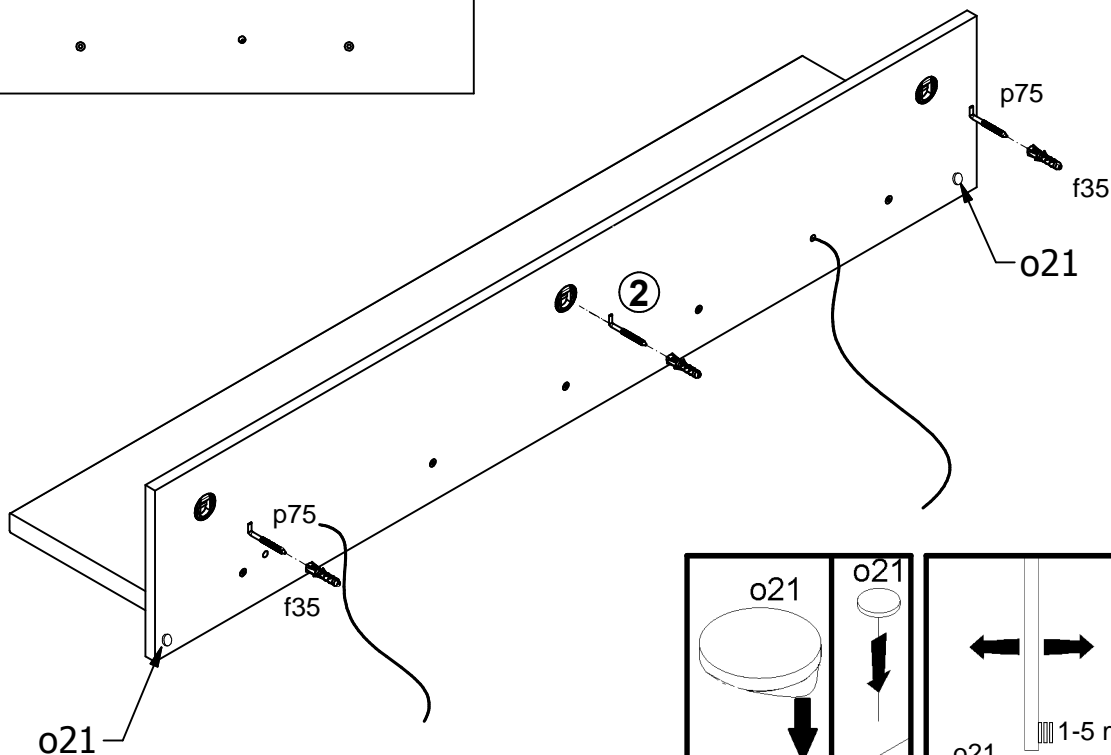
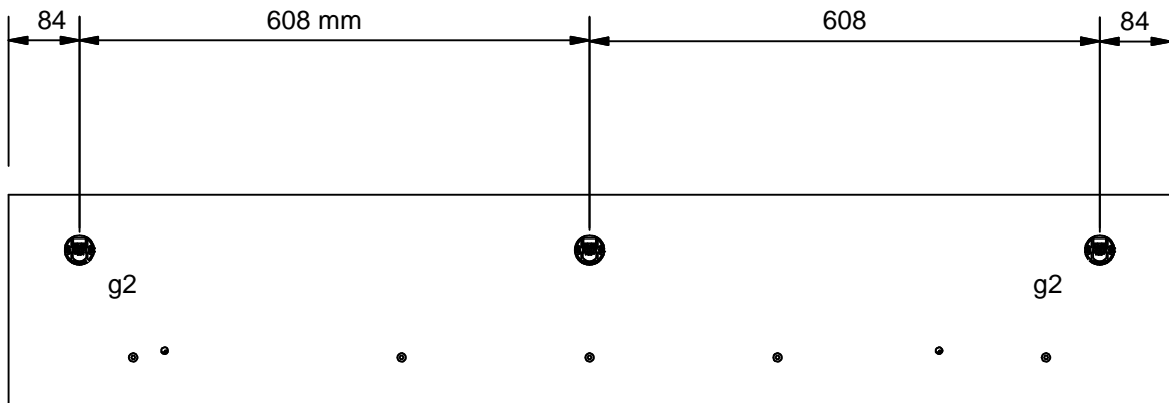
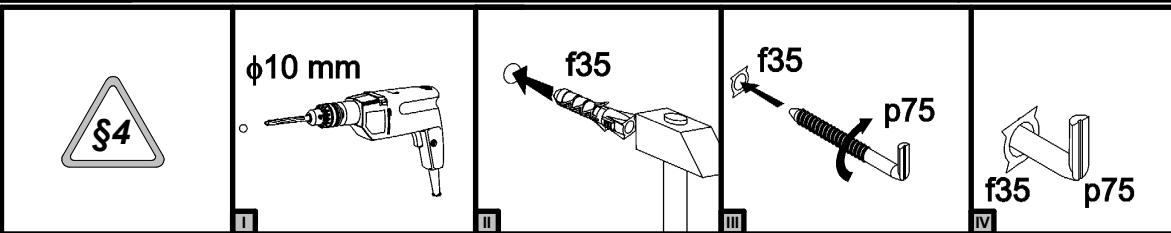

4

