

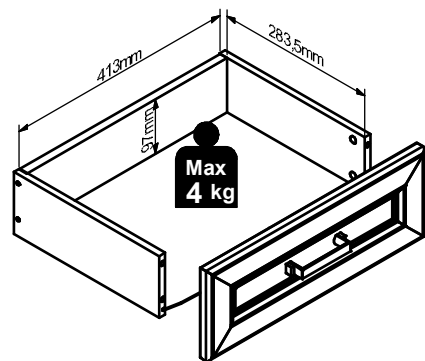

1x c453	12x Ø6x13 mm e3	28x Ø8x30 mm f1	4x Ø6,5x40 mm f25	2x M4x12 mm j3
4x k13 2	16x Ø4x30 mm p9	6x Ø2,9x16 mm p55	26x Ø15x12 mm #16 r1	4x Ø12x10,5 mm #12 r15
30x 20x11 r42	1x 300mm w125L	1x 300mm w125P	4x w267	8x Ø 20mm s68

A	B	C1	C2	C3	D
1	S530-0006	446	160	22	1/1
2	S530-1010	494	353	16	1/1
3	S530-1011	494	353	16	1/1
4	S530-2005	538	384	28	1/1
5	S530-2006	538	384	16	1/1
6	S530-4003	494	504	16	1/1
7	S530-4004	350	80	16	1/1
8	S530-4107	536	72	16	1/1
9	S530-4108	351	72	16	1/1
10	S530-5005	494	43	19	1/1
11	WSP-9401	423	308	2,5	1/1
12	ZQ6-5237	413	97	15	1/1
13	ZQ6-517	300	110	12	1/1
14	ZQ6-518	300	110	12	1/1

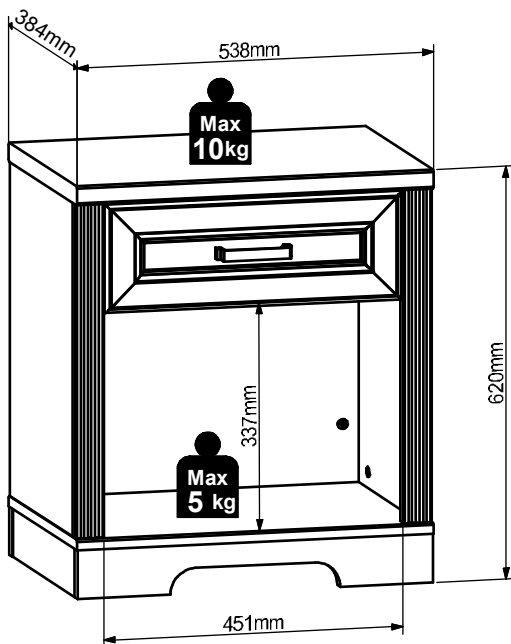

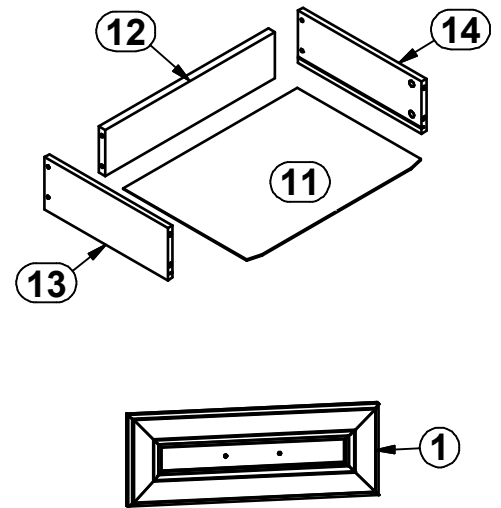
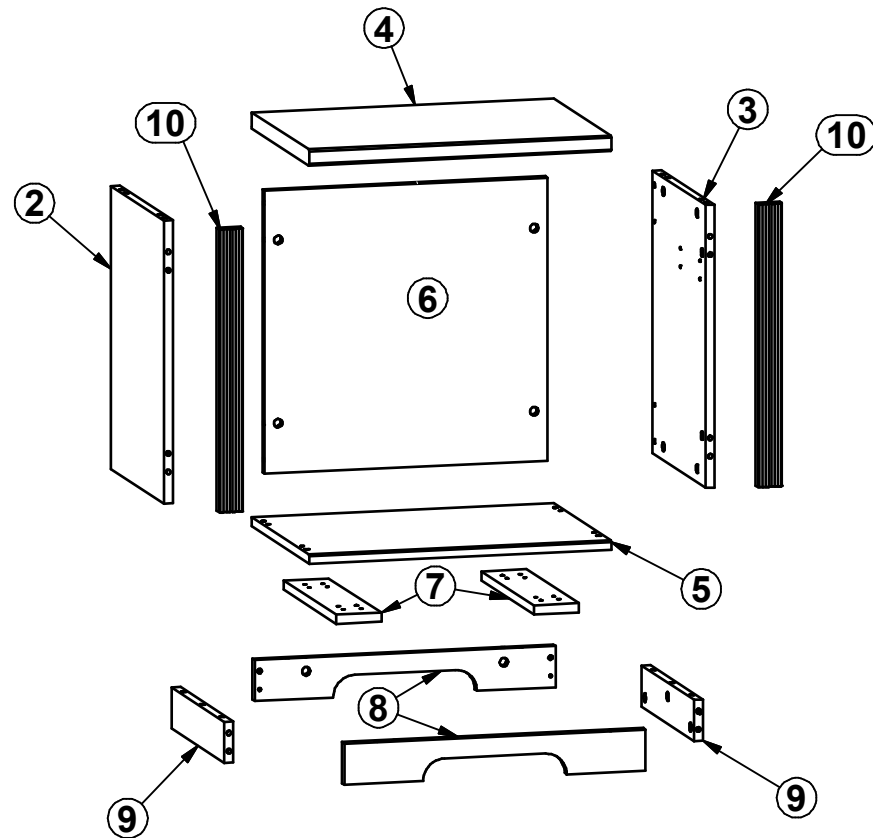

1

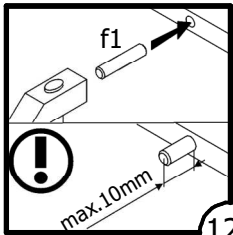

12x

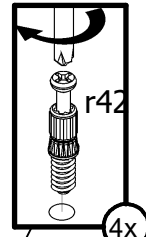

4x

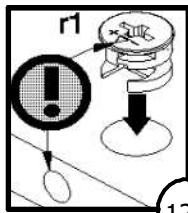

12x

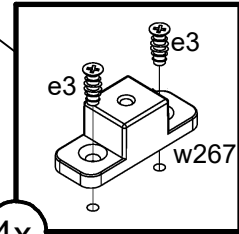

4x

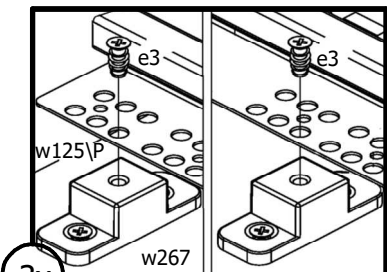

3x

2

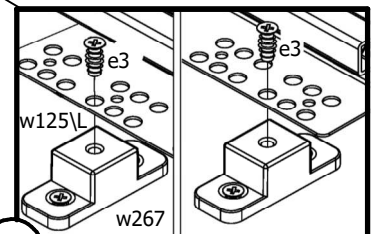
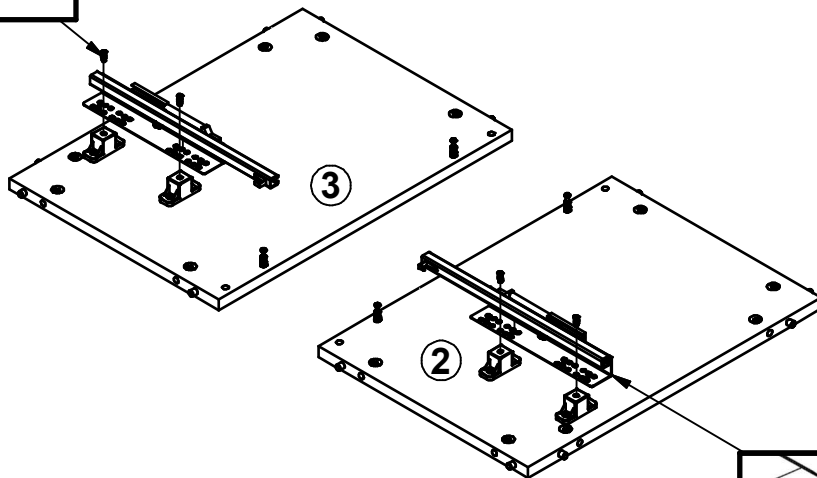

3x

3

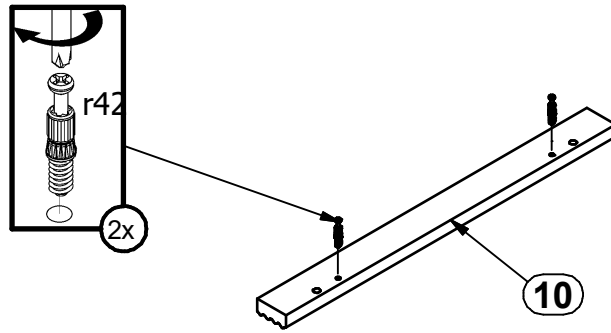

2x

4

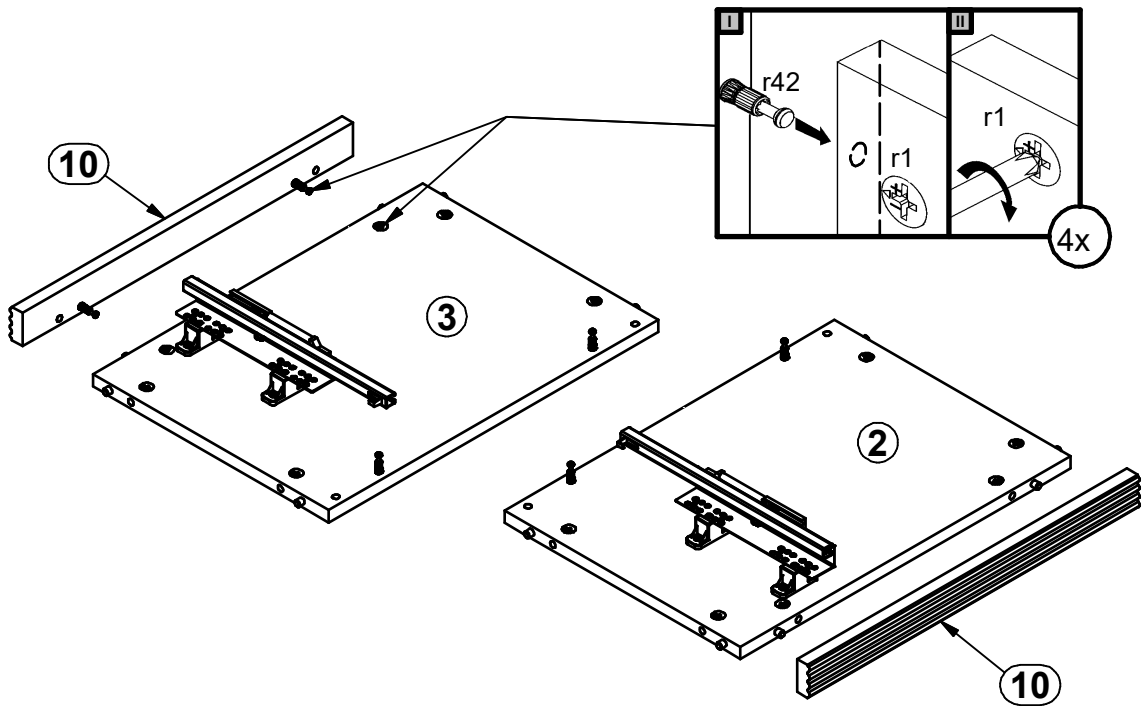

5

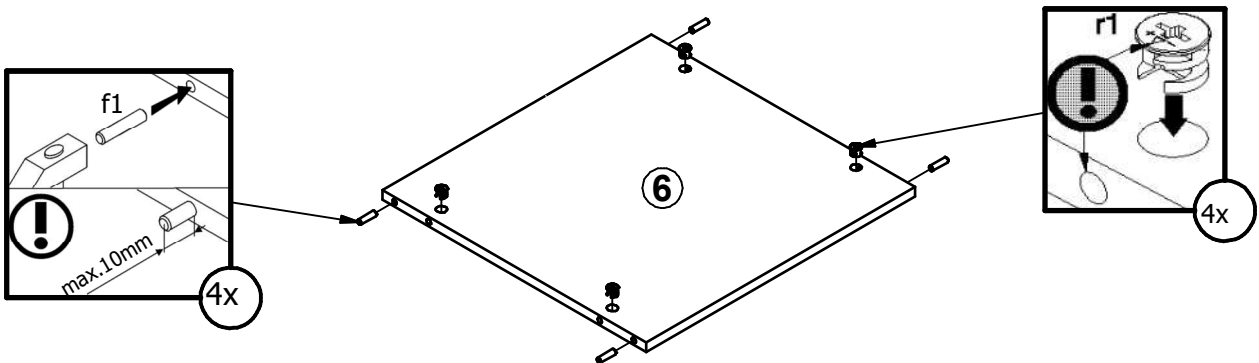

6

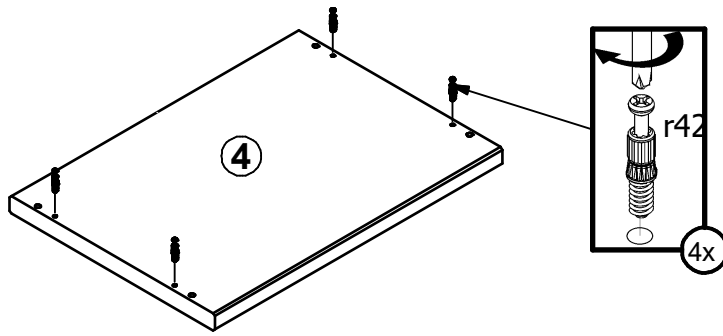

7

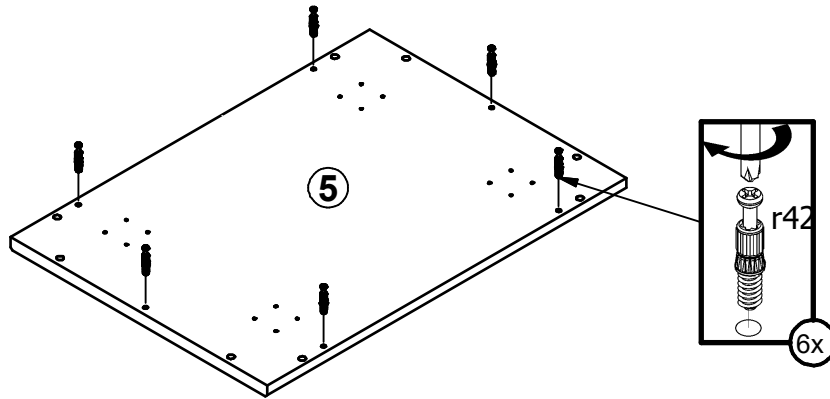

8

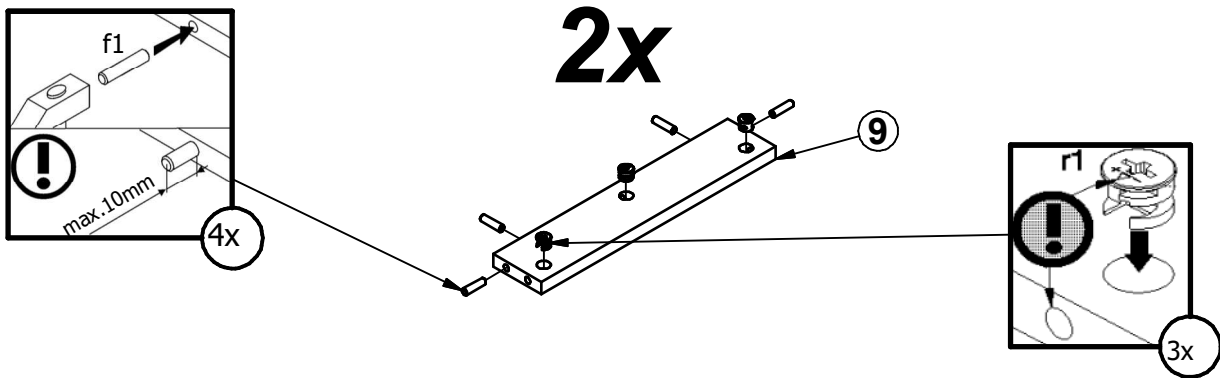

9

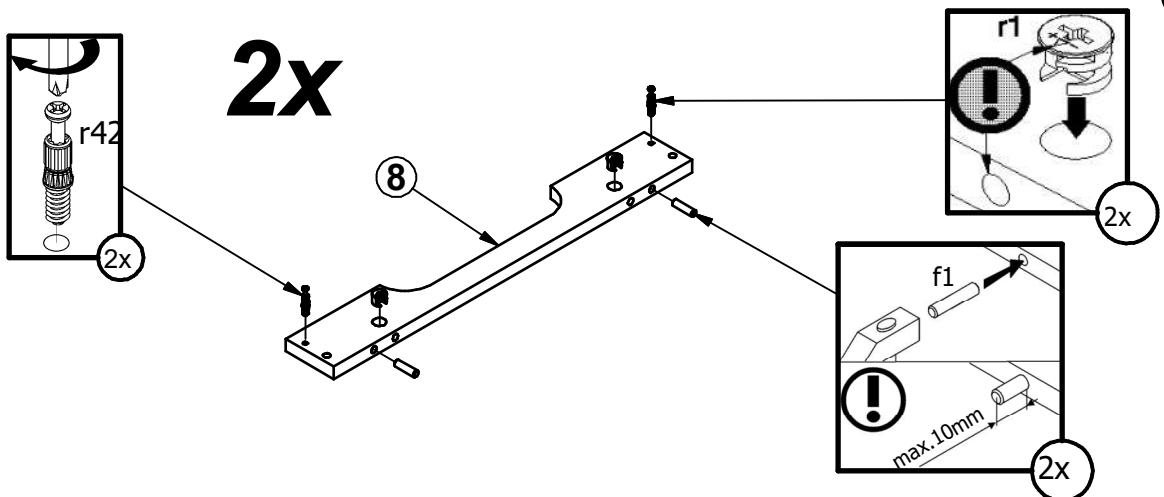

10

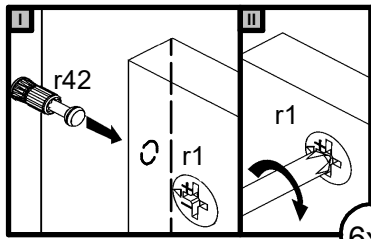
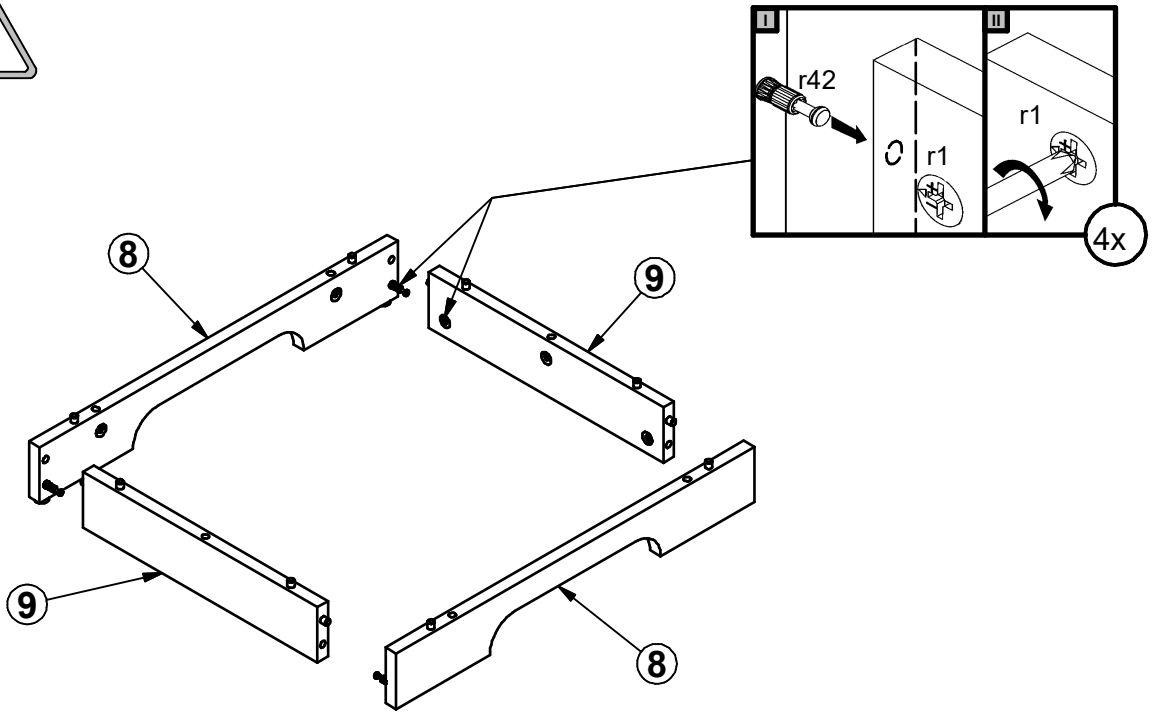

11

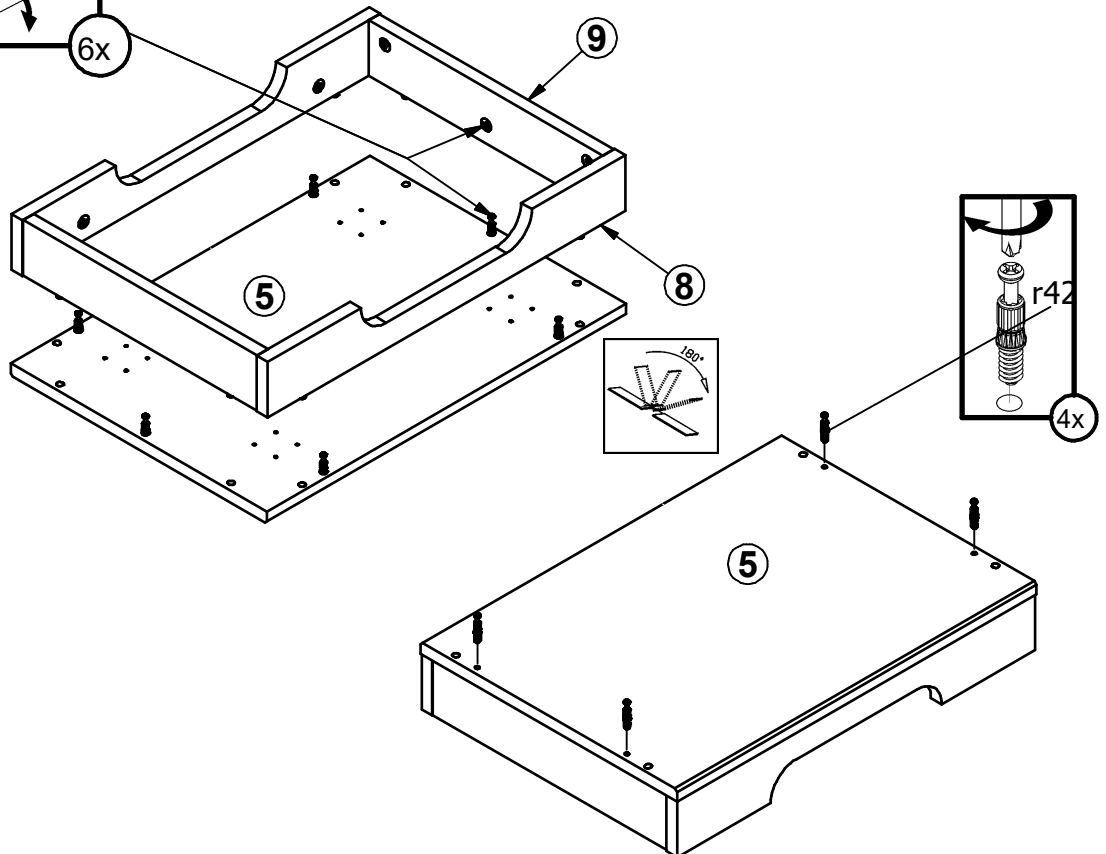

12

I

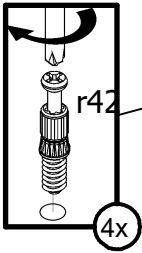
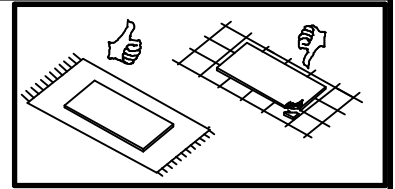
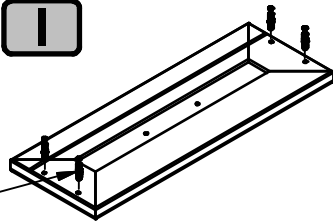

II

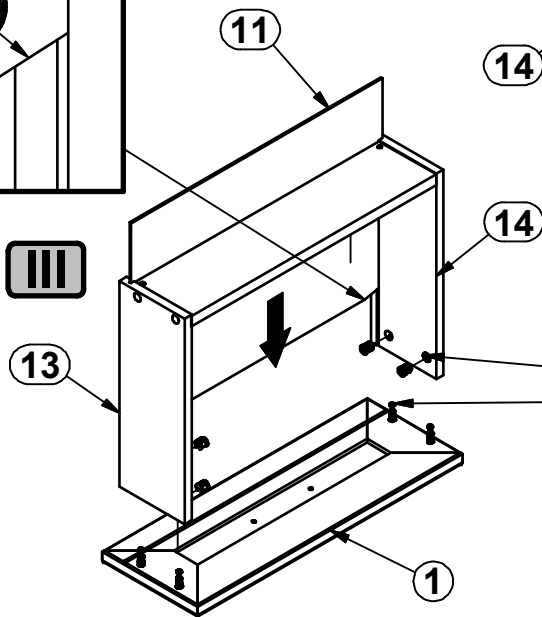
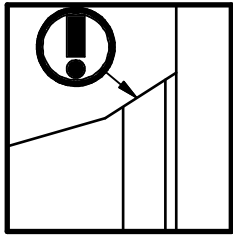
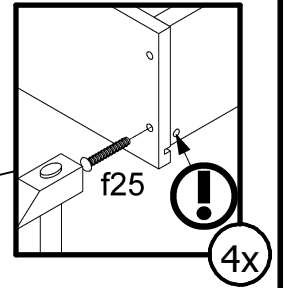
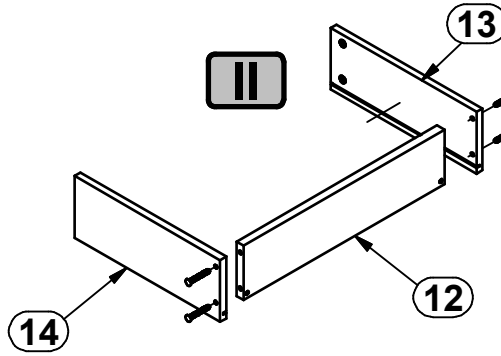

III

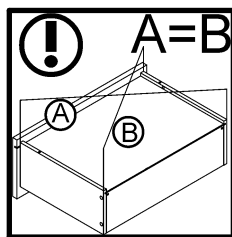
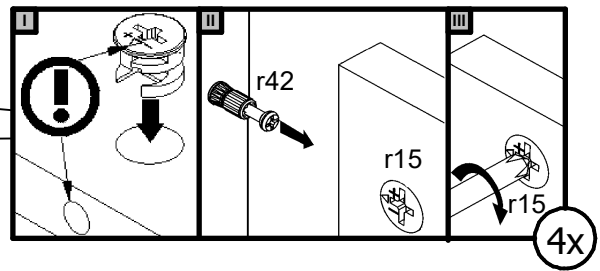

IV

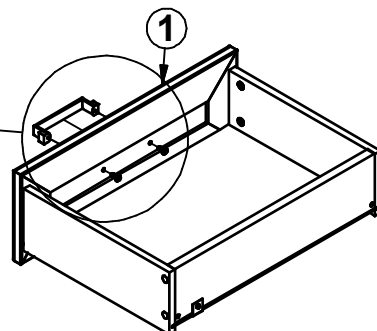
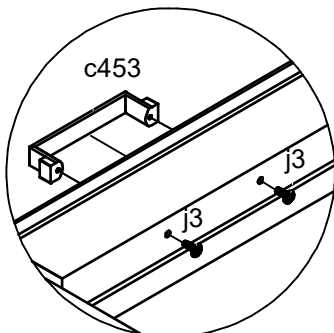
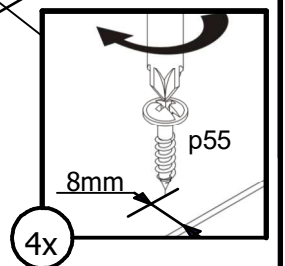
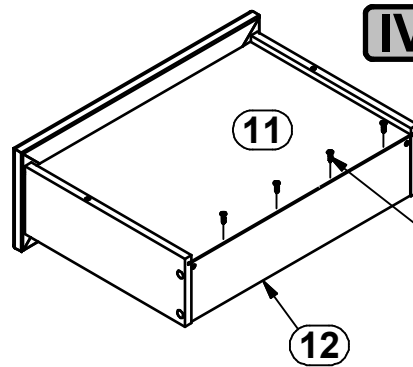

V

13

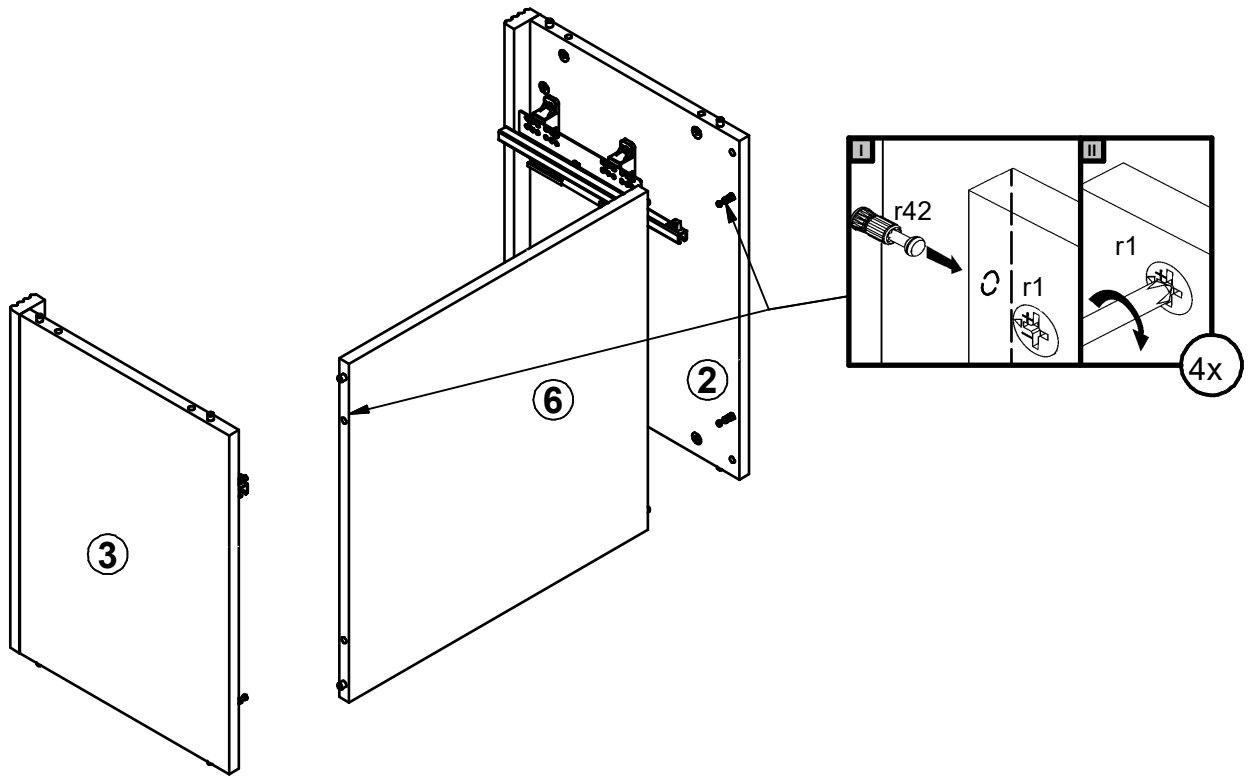

14

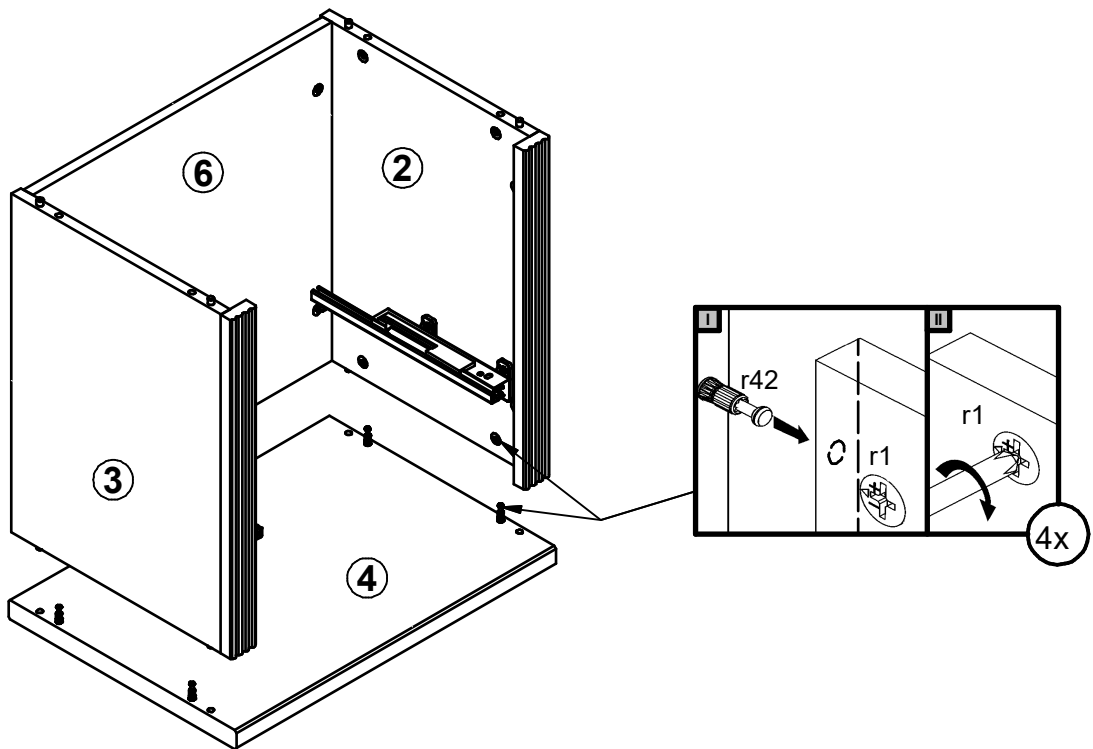

15

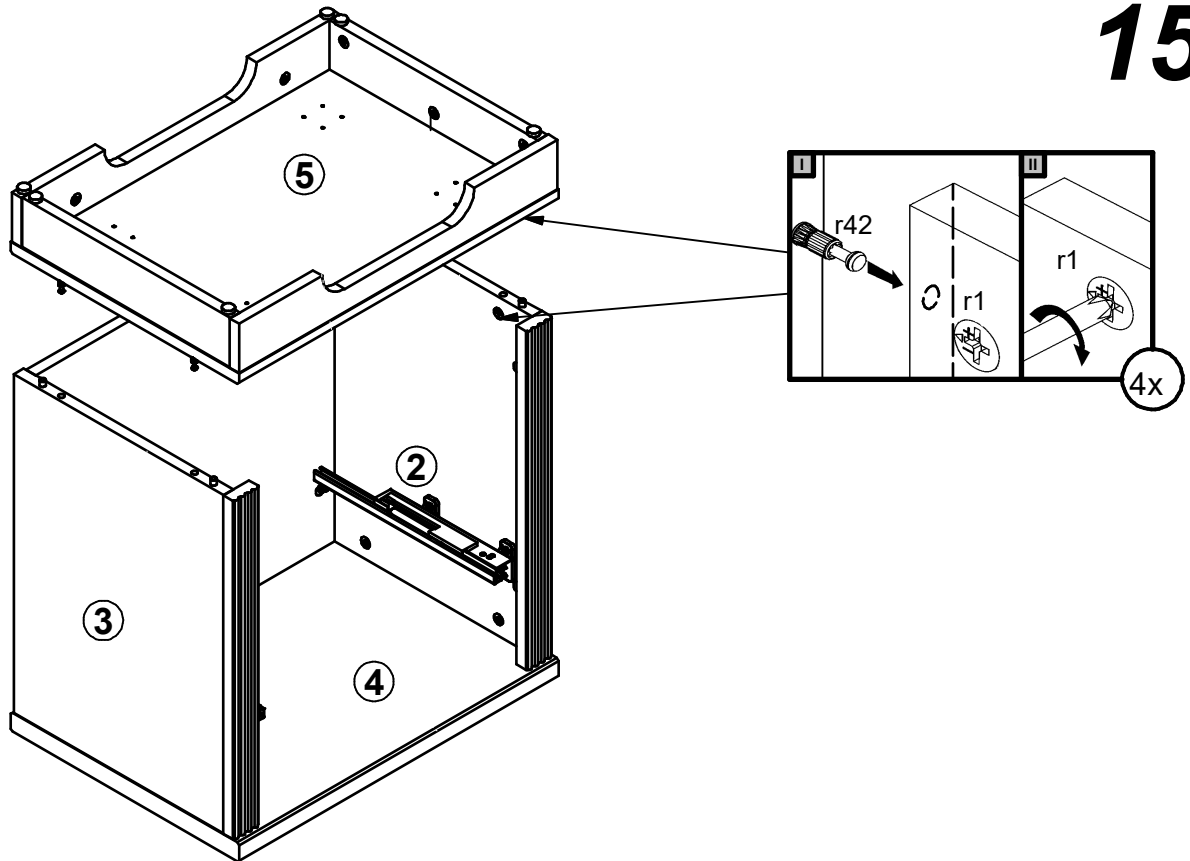

16

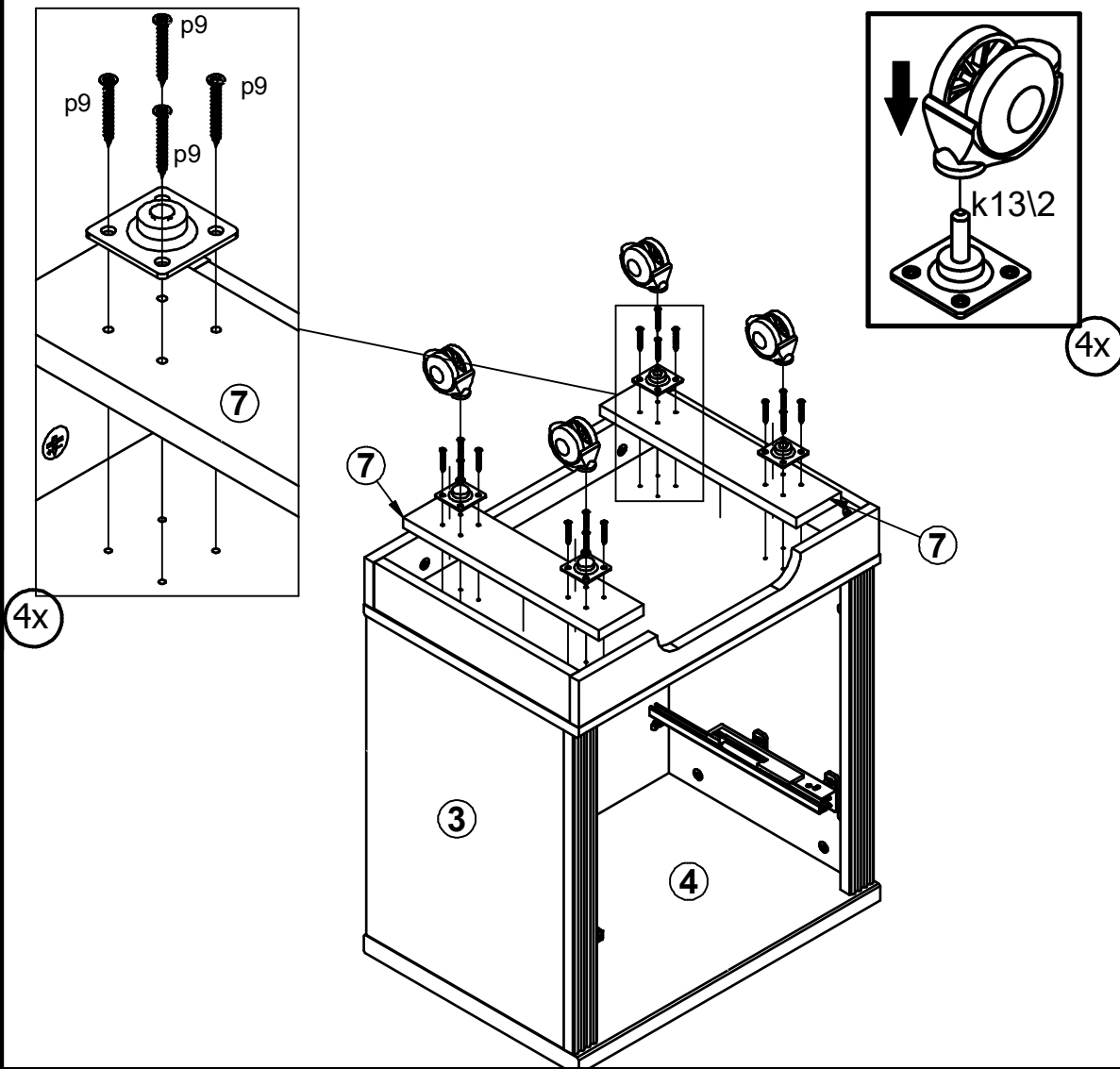

17

